

Solderless terminals

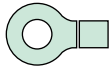

RING TONGUE (R type) Vinyl-insulated with copper sleeve

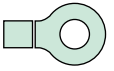

The terminal barrel is first covered with a copper sleeve and then insulated with vinyl; it is extremely resistant to vibration.

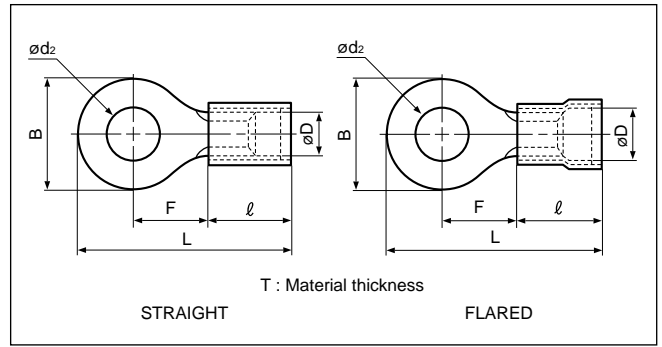

Certificate No.: E42024 LR20812

Applicable Wire AWG #(mm ²)	Stud size		Part No.		Standard	Dimensions mm (in.)									Color	Tool No.	Qty/box
	American	Metric	Straight	Flared		ød ₂	B	L	F	ℓ	øD		T				
26 to 22 (0.2 to 0.5)	1-2	2	VD0.5-2	—		2.2 (.087)	5.2 (.205)	16.4 (.646)	5.8 (.228)	8.0 (.315)	2.2 (.087)	2.5 (.098)	0.5 (.020)	Yellow	YNT-2622 YA-1 YA-2	1,000	
	3-4	3	VD0.5-3	—		3.2 (.126)	5.2 (.205)	16.4 (.646)	5.8 (.228)								
	5-6	3.5	VD0.5-3.7	—		3.7 (.146)	6.6 (.260)	19.0 (.748)	7.7 (.303)								
	8	4	VD0.5-4	—		4.3 (.169)	6.6 (.260)	19.0 (.748)	7.7 (.303)	8.3 (.327)							
	10	5	VD0.5-5	—		5.3 (.209)	8.0 (.315)	19.0 (.748)	7.0 (.276)								
	1-2	2	—	FVD0.5-2		2.2 (.087)	5.2 (.205)	16.7 (.657)	5.8 (.228)								
	3-4	3	—	FVD0.5-3		3.2 (.126)	5.2 (.205)	16.7 (.657)	5.8 (.228)								
8	4	—	FVD0.5-4	4.3 (.169)	6.6 (.260)	19.3 (.760)	7.7 (.303)										
10	5	—	FVD0.5-5	5.3 (.209)	8.0 (.315)	19.3 (.760)	7.0 (.276)										
22 to 16 (0.25 to 1.65)	1-2	2	VD1.25-2	FVD1.25-2		2.2 (.087)	5.5 (.217)	16.3 (.642)	4.0 (.157)	9.6 (.378)	3.5 (.138)	4.0 (.157)	0.8 (.031)	Red	YNT-2216 YA-1 YA-2 YA-4	1,000	
	3-4	3	VD1.25-3	FVD1.25-3		3.2 (.126)	5.5 (.217)	16.3 (.642)	4.0 (.157)								
	3-4	3	VD1.25-MS3	FVD1.25-MS3		3.2 (.126)	5.5 (.217)	18.0 (.709)	5.6 (.220)								
	3-4	3	VD1.25-L3	—		3.2 (.126)	8.0 (.315)	20.6 (.811)	7.0 (.276)								
	5-6	3.5	VD1.25-3.7	—		3.7 (.146)	5.5 (.217)	16.3 (.642)	4.0 (.157)								
	5-6	3.5	VD1.25-M3	FVD1.25-M3		3.7 (.146)	6.6 (.260)	19.2 (.756)	6.3 (.248)								
	8	4	VD1.25-M4	FVD1.25-M4		4.3 (.169)	6.6 (.260)	19.2 (.756)	6.3 (.248)								
	8	4	VD1.25-4	FVD1.25-4		4.3 (.169)	8.0 (.315)	20.6 (.811)	7.0 (.276)								
	10	5	VD1.25-5	FVD1.25-5		5.3 (.209)	8.0 (.315)	20.6 (.811)	7.0 (.276)								
	1/4	6	—	FVD1.25-6		6.4 (.252)	11.6 (.457)	26.5 (1.043)	11.1 (.437)								
	5/16	8	VD1.25-8	FVD1.25-8		8.4 (.331)	11.6 (.457)	26.5 (1.043)	11.1 (.437)								
3/8	10	VD1.25-10	—	10.5 (.413)	13.6 (.535)	30.3 (1.193)	13.9 (.547)										
16 to 14 (1.04 to 2.63)	1-2	2	VD2-S2	FVD2-S2		2.2 (.087)	6.4 (.252)	17.1 (.673)	4.3 (.169)	9.6 (.378)	4.1 (.161)	4.7 (.185)	0.8 (.031)	Blue	YNT-1614 YA-1 YA-2 YA-4	1,000	
	3-4	3	VD2-MS3	FVD2-MS3		3.2 (.126)	5.5 (.217)	18.0 (.709)	5.6 (.220)								
	3-4	3	VD2-S3.3	FVD2-S3.3		3.2 (.126)	6.4 (.252)	17.1 (.673)	4.3 (.169)								
	3-4	3	—	FVD2-3		3.2 (.126)	8.5 (.335)	21.6 (.850)	7.8 (.307)								
	5-6	3.5	VD2-S3	FVD2-S3		3.7 (.146)	6.4 (.252)	17.1 (.673)	4.3 (.169)								
	5-6	3.5	VD2-M3	FVD2-M3		3.7 (.146)	6.6 (.260)	19.2 (.756)	6.3 (.248)								
	5-6	3.5	VD2-P3.5	—		3.7 (.146)	7.0 (.276)	20.8 (.819)	7.7 (.303)								
	8	4	VD2-M4	FVD2-M4		4.3 (.169)	6.6 (.260)	19.2 (.756)	6.3 (.248)								
	8	4	VD2-P4	FVD2-P4		4.3 (.169)	7.0 (.276)	20.8 (.819)	7.7 (.303)								
	8	4	VD2-4	FVD2-4		4.3 (.169)	8.5 (.335)	21.6 (.850)	7.8 (.307)								
	10	5	VD2-M5	FVD2-M5		5.3 (.209)	8.5 (.335)	21.6 (.850)	7.8 (.307)								
	10	5	VD2-5	FVD2-5		5.3 (.209)	9.5 (.374)	21.6 (.850)	7.3 (.287)								
	1/4	6	VD2-6	FVD2-6		6.4 (.252)	12.0 (.472)	26.6 (1.047)	11.0 (.433)								
	5/16	8	VD2-8	FVD2-8		8.4 (.331)	12.0 (.472)	26.6 (1.047)	11.0 (.433)								
	3/8	10	VD2-10	FVD2-10		10.5 (.413)	13.6 (.535)	30.3 (1.193)	13.9 (.547)								
	1/2	12	VD2-12	—		13.0 (.512)	19.0 (.748)	35.8 (1.409)	16.7 (.657)								
	1/2	14	VD2-14	FVD2-14		15.0 (.591)	27.0 (1.063)	44.3 (1.744)	21.2 (.835)								
3/4	20	VD2-20	FVD2-20	21.0 (.827)	27.0 (1.063)	44.3 (1.744)	21.2 (.835)										
12 to 10 (2.63 to 6.64)	3-4	3	VD5.5-3	FVD5.5-3		3.2 (.126)	9.5 (.374)	27.0 (1.063)	8.3 (.327)	14.0 (.551)	5.7 (.224)	6.5 (.256)	1.0 (.039)	Yellow	YNT-1210S YA-4	500	
	5-6	3.5	—	FVD5.5-S3		3.7 (.146)	7.2 (.283)	23.5 (.925)	5.9 (.232)								
	8	4	VD5.5-S4	FVD5.5-S4		4.3 (.169)	7.2 (.283)	23.5 (.925)	5.9 (.232)								
	8	4	VD5.5-4	FVD5.5-4		4.3 (.169)	9.5 (.374)	27.0 (1.063)	8.3 (.327)								
	10	5	VD5.5-5	FVD5.5-5		5.3 (.209)	9.5 (.374)	27.0 (1.063)	8.3 (.327)								
	1/4	6	VD5.5-6	FVD5.5-6		6.4 (.252)	12.0 (.472)	33.0 (1.299)	13.0 (.512)								
	1/4	6	—	FVD5.5-S6		6.4 (.252)	13.2 (.520)	29.6 (1.165)	9.0 (.354)								
	5/16	8	VD5.5-S8	FVD5.5-S8		8.4 (.331)	13.2 (.520)	29.6 (1.165)	9.0 (.354)								
	5/16	8	VD5.5-8	FVD5.5-8		8.4 (.331)	15.0 (.591)	35.2 (1.386)	13.7 (.539)								
	3/8	10	VD5.5-10	FVD5.5-10		10.5 (.413)	15.0 (.591)	35.2 (1.386)	13.7 (.539)								
	1/2	14	VD5.5-14	FVD5.5-14		15.0 (.591)	32.0 (1.260)	55.3 (2.177)	25.3 (.996)								
	5/8	16	VD5.5-16	FVD5.5-16		17.0 (.669)	32.0 (1.260)	55.3 (2.177)	25.3 (.996)								
	11/16	18	VD5.5-18	FVD5.5-18		19.0 (.748)	32.0 (1.260)	55.3 (2.177)	25.3 (.996)								
	3/4	20	VD5.5-20	FVD5.5-20		21.0 (.827)	32.0 (1.260)	55.3 (2.177)	25.3 (.996)								

Note:1) The part numbers indicated in the above table are for products with a brazed seam.

When ordering products with a butted seam, add the prefix "WS" to the part number (ex. VD2-4 → **VDWS2-4**).

2) To order products with nylon insulation, change the "V" in the part number prefix to "N" (ex. **FVD2-4** → **FND2-4**).

Because nylon absorbs moisture, care must be taken concerning storage.

3) Delivery lead times may vary depending on the product. Contact JST for details.

Solderless terminals

RING TONGUE (R type) Vinyl-insulated with copper sleeve (Medium size)

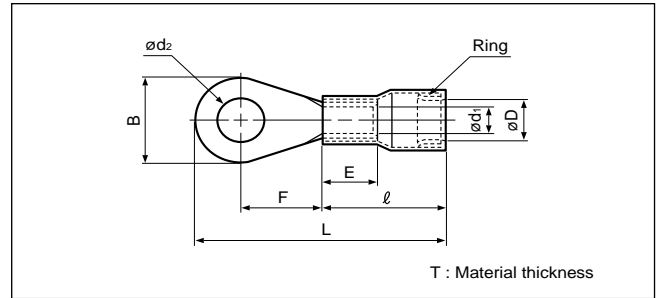
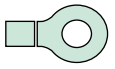
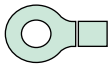

Certificate No.: E42024 LR20812

Applicable Wire AWG#(mm ²)	Stud size		Part No.	Standard	Dimensions mm (in.)									Color	Tool No.	Qty/box	
	American	Metric			ϕd_2	B	L	F	E	ℓ	d_1	ϕD (min.)	T				
8 (6.64 to 10.52)	10	5	FVD8-5		5.3 (.209)	10.3 (.406)	36.3(1.429)	10.6 (.417)	8.3 (.327)	19.2 (.756)	4.6 (.181)	7.5 (.295)	1.1 (.043)	Red	YF-1 E-4	YNE-38	200
	1/4	6	FVD8-6		6.4 (.252)	11.6 (.457)	36.3(1.429)	11.3 (.445)									
	5/16	8	FVD8-8		8.4 (.331)	14.4 (.567)	38.8(1.528)	12.4 (.488)									
	3/8	10	FVD8-10		10.5 (.413)	14.4 (.567)	38.8(1.528)	12.4 (.488)									
6 (10.52 to 16.78)	10	5	FVD14-5		5.3 (.209)	12.2 (.480)	39.2(1.543)	13.1 (.516)	10.9 (.429)	20.0 (.787)	5.7 (.224)	10.5 (.413)	1.1 (.043)	Blue	YF-1 E-4	YNE-38	100
	1/4	6	FVD14-6		6.4 (.252)	12.2 (.480)	39.2(1.543)	13.1 (.516)									
	5/16	8	FVD14-8		8.4 (.331)	15.3 (.602)	42.4(1.669)	14.7 (.579)									
	3/8	10	FVD14-10		10.5 (.413)	15.3 (.602)	42.4(1.669)	14.7 (.579)									
4 (16.78 to 26.66)	1/4	6	FVD22-6		6.4 (.252)	13.8 (.543)	44.0(1.732)	14.1 (.555)	12.0 (.472)	23.0 (.906)	7.2 (.284)	11.5 (.453)	1.3 (.051)	Yellow	YF-1 E-4	YNE-38	100
	5/16	8	FVD22-8		8.4 (.331)	15.9 (.626)	46.1(1.815)	15.1 (.594)									
	3/8	10	FVD22-10		10.5 (.413)	15.9 (.626)	46.1(1.815)	15.1 (.594)									

Note:1) Delivery lead times may vary depending on the product. Contact JST for details.

Solderless terminals

RING TONGUE (R type) Non-insulated (Heavy duty)

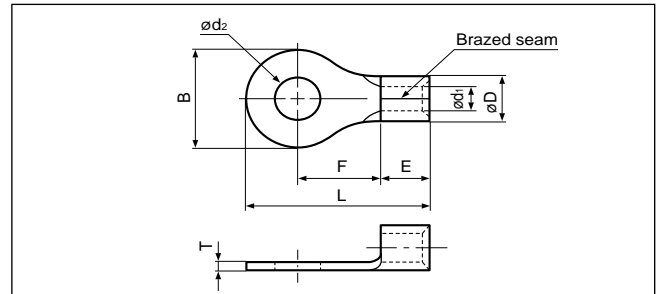
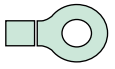
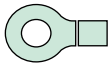

Applicable Wire AWG#(mm ²)	Stud size		Part No.	Standard	Dimensions mm (in.)									Tool No.	Qty/box
	American	Metric			ϕd_2	B	L	F	E	ϕD	ϕd_1	T			
E type	22 to 16 (0.25 to 1.65)	5-6	3.5	1.25-3E	3.7 (.146)	8.0 (.315)	16.4 (.646)	7.6 (.299)	4.8 (.189)	4.0 (.157)	1.9 (.075)	1.0 (.039)	YHT-2210 YA-1, YA-2 YA-4	1,000	
		8	4	1.25-4E	4.3 (.169)	8.0 (.315)	16.4 (.646)	7.6 (.299)							
	16 to 14 (1.04 to 2.63)	8	4	2-4E	4.3 (.169)	9.2 (.362)	18.6 (.732)	7.2 (.284)	6.8 (.268)	5.5 (.217)	2.3 (.091)	1.6 (.063)	YHT-2210 YA-1 YA-2 YA-4	1,000	
		10	5	2-5E	5.3 (.209)	9.2 (.362)	18.6 (.732)	7.2 (.284)							
		1/4	6	2-6E	6.4 (.252)	13.6 (.535)	25.3 (.996)	11.7 (.461)							
		5/16	8	2-8E	8.4 (.331)	13.6 (.535)	25.3 (.996)	11.7 (.461)							
ES type	16 to 14 (1.04 to 2.63)	5/16	8	2-8ES	8.4 (.331)	13.5 (.532)	24.2 (.953)	11.3 (.445)	6.2 (.244)	5.5 (.217)	3.0 (.118)	1.2 (.047)	-	500	
		3/8	10	2-10ES	10.5 (.413)	13.5 (.532)	24.2 (.953)	11.3 (.445)							

Note:1) The ϕD of products with the suffix "E" at the end of the part number is one size larger than the non-insulated terminal with the same part number.

For the crimping tool jaws, select one size larger from among the three jaw sizes on the YHT-2210 crimping tool.

2) Contact JST concerning minimum lot size.

3) The part numbers indicated in the above table are for products with a brazed seam.

When ordering products with a butted seam, add the prefix "WS" to the part number (ex. 2-4E → WS2-4E).

4) Delivery lead times may vary depending on the product. Contact JST for details.